

Pnömatik Yön Denetim Valfi

Bobinli Valfler R1/4"

MAG®



SV - 1/4 -

| | | | | | |
|--------|--------------|-------------|------------------|---------------|----------------|
| Ölçü | Yol Sayısı | Uyarı Şekli | Geri Geliş Şekli | Bobin Tipi | Bobin Gerilimi |
| R 1/4" | 3 | B Bobin | B Bobin | Dik | 12 V DC |
| | 5 | | H Hava Uyarı | Y Yatık | 24 V DC |
| | Konum Sayısı | | Y Yay | | 24 V AC |
| | 2 | | | A Normal Açık | 110 V AC |
| | 3 | | | Normal Kapalı | 220 V AC |

SV-1/4-3/2

Yatık Bobinli Valf

SV-1/4-3/2-B-B-Y

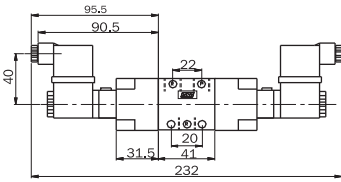

| Simge | Tip | Çalışma Basıncı (bar) | Ağırlık (g) |
|-------|------------------|-----------------------|-------------|
| | SV-1/4-3/2-B-B-Y | 1....10 | 840 |
| | SV-1/4-3/2-B-Y-Y | 3....10 | 565 |

SV-1/4-3/2-B-Y-Y

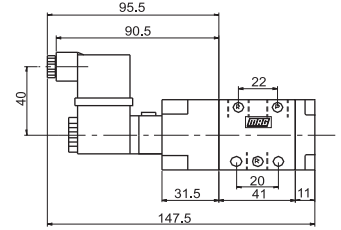

Dik Bobinli Valf

SV-1/4-3/2-B-B

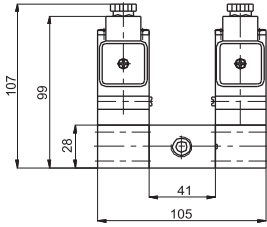

| Simge | Tip | Çalışma Basıncı (bar) | Ağırlık (g) |
|-------|----------------|-----------------------|-------------|
| | SV-1/4-3/2-B-B | 1....10 | 1215 |
| | SV-1/4-3/2-B-H | 1....10 | 920 |
| | SV-1/4-3/2-B-Y | 3....10 | 790 |

SV-1/4-3/2-B-Y

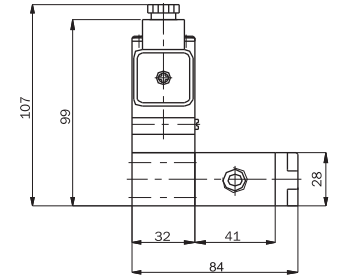

SV-1/4-3/2-B-H

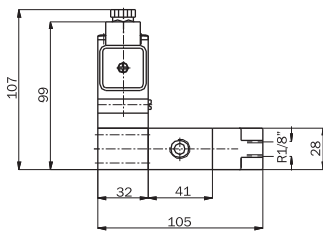

BOBİN KAPAĞININ ÜSTTEN GÖRÜNÜŞÜ

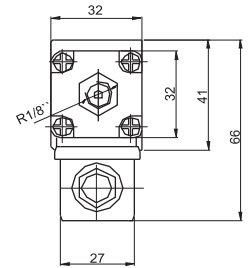

SV - 1/4 VALF ADASI ÖLÇÜLERİ

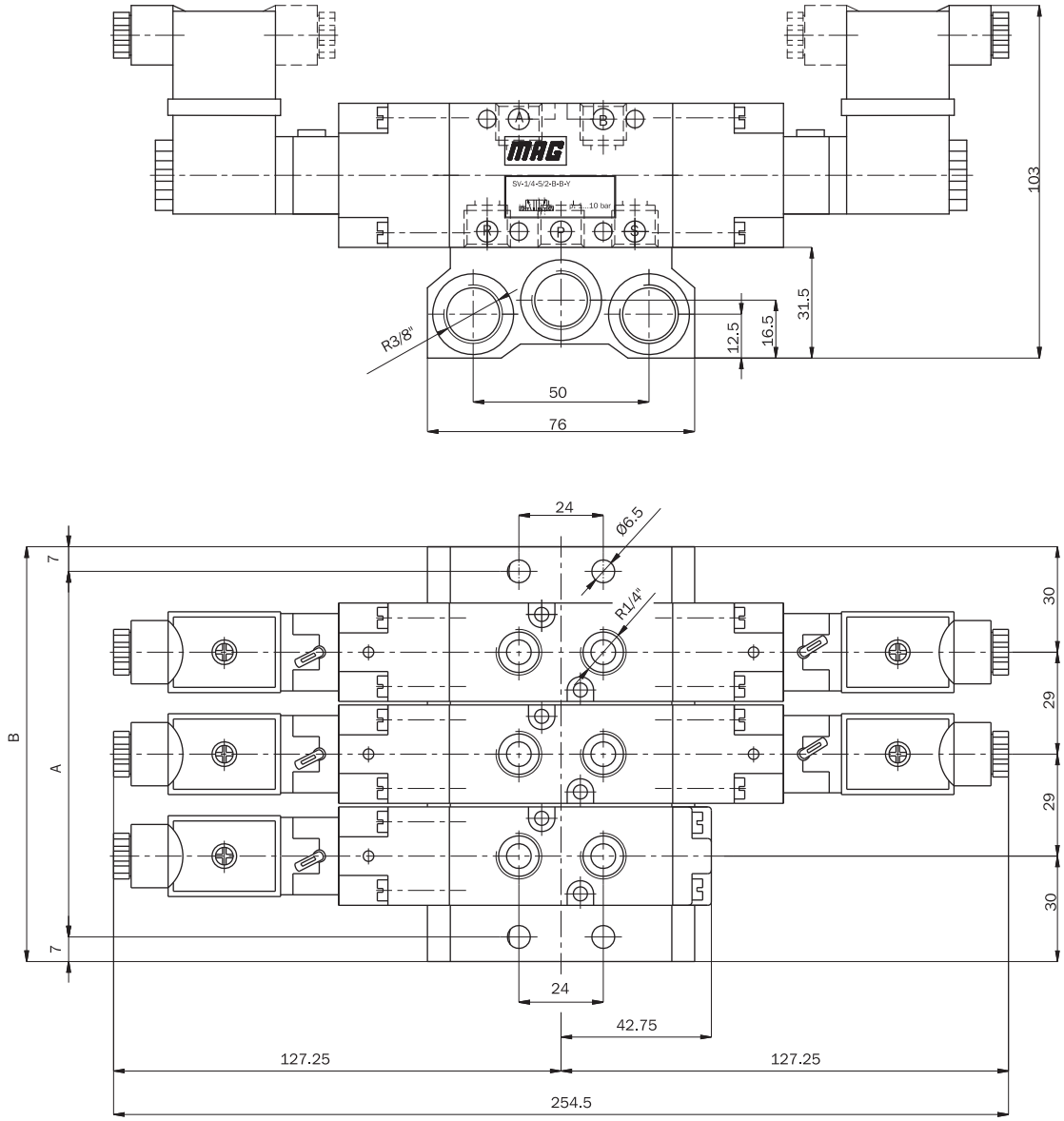

SİPARİŞ ŞEKLİ ⁽¹⁾
SVP - 1/4 - . .

Valf Sayısı

| VALF SAYISI | A | B |
|-------------|-----|-----|
| 2 | 75 | 89 |
| 3 | 104 | 118 |
| 4 | 133 | 147 |
| 5 | 162 | 176 |
| 6 | 191 | 205 |
| 7 | 220 | 234 |
| 8 | 249 | 263 |
| 9 | 278 | 292 |
| 10 | 307 | 321 |

(1) BU ADA TİPİ BEŞ YOLLU İKİ KONUMLU VE BEŞ YOLLU ÜÇ KONUMLU VALF TİPLERİ İÇİN GEÇERLİDİR.

SV-1/4-5/2

Yatık Bobinli Valf

SV-1/4-5/2-B-B-Y

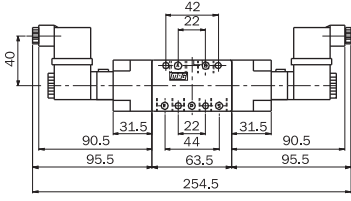

| Simge | Tip | Çalışma Basıncı (bar) | Ağırlık (g) |
|-------|------------------|-----------------------|-------------|
| | SV-1/4-5/2-B-B-Y | 1....10 | 780 |
| | SV-1/4-5/2-B-Y-Y | 3....10 | 505 |
| | SV-1/4-5/2-B-H-Y | 1....12 | 1055 |

SV-1/4-5/2-B-Y-Y

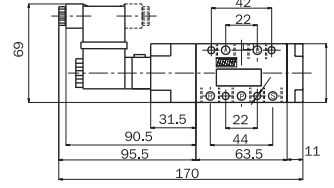

SV-1/4-5/2-B-H-Y

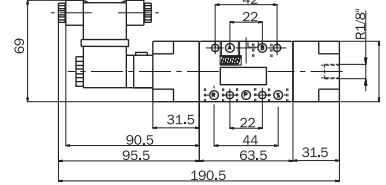

Dik Bobinli Valf

SV-1/4-5/2-B-B

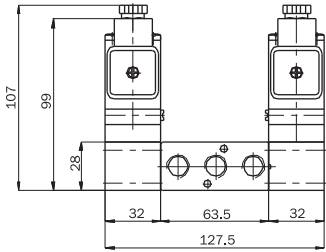

SV-1/4-5/2-B-H

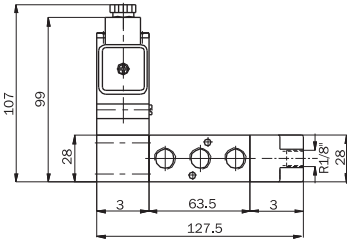

| Simge | Tip | Çalışma Basıncı (bar) | Ağırlık (g) |
|-------|----------------|-----------------------|-------------|
| | SV-1/4-5/2-B-B | 1....10 | 1400 |
| | SV-1/4-5/2-B-H | 1....12 | 1055 |
| | SV-1/4-5/2-B-Y | 3....10 | 700 |

SV-1/4-5/2-B-Y

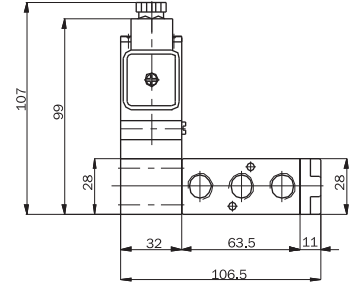

BOBİN KAPAĞININ ÜSTTEN GÖRÜNÜŞÜ

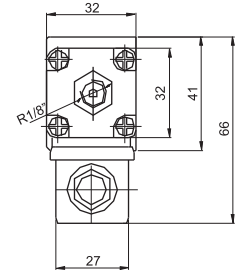

SV-1/4-5/3

Yatık Bobinli Valf

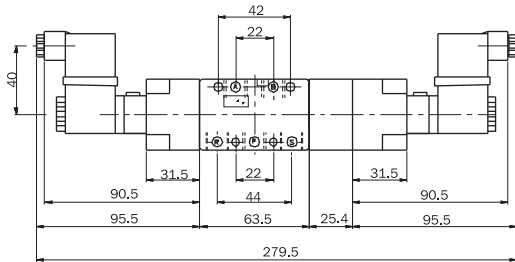

| Simge | Tip | Çalışma Basıncı (bar) | Ağırlık (g) |
|-------|------------------|-----------------------|-------------|
| | SV-1/4-5/3-B-B-Y | 1....10 | 880 |

Dik Bobinli Valf

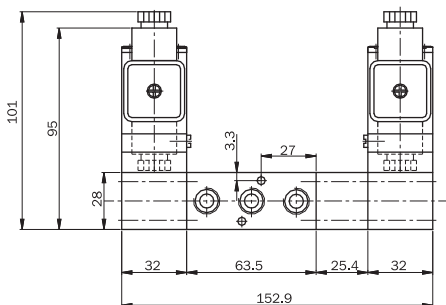

| Simge | Tip | Çalışma Basıncı (bar) | Ağırlık (g) |
|-------|----------------|-----------------------|-------------|
| | SV-1/4-5/3-B-B | 1....10 | 1400 |